

Analysis of Voltage Sag Due to Short Circuit on the Sub System in Central Sumatera

Hendry
Electrical Engineering Department,
Universitas Lancang Kuning
Pekanbaru, Indonesia

*Hamzah Eteruddin
Electrical Engineering Department,
Universitas Lancang Kuning
Pekanbaru, Indonesia

Atmam
Electrical Engineering Department,
Universitas Lancang Kuning
Pekanbaru, Indonesia

*corresponding author: Hamzah Eteruddin hamzah@unilak.ac.id

Abstract— Power quality is closely related to electrical energy which is directly related to voltage and current interference. Electrical equipment used daily requires good power quality. The thing that affects the quality of the power is the voltage dip. Based on the IEEE 1159-1995 standard, voltage sag is a decrease in RMS voltage with duration of 0.5 cycle to 1 minute. Sag voltage that occurs can have an effect on electronic equipment and other problems that often arise in the industrial environment. Therefore, a short circuit fault analysis was conducted to determine the voltage sag based on the type of fault in the sub system in Central Sumatera. Short circuit fault analysis is done using Power world Simulator 7.0 Students Edition. This study is intended to determine the sag voltage when there is a short circuit fault. The biggest voltage sag occurs when a short circuit fault of single phase to ground at 75% fault location and the smallest voltage sag when the three-phase short circuit of 0.7 fault location.

Keywords— *Power quality, Short circuit, Voltage sag.*

I. INTRODUCTION

Good electrical power quality is a very important contribution to human life, in the modern century as it is now a very vital role in the fields of telecommunications, information technology, industry, education, and others. Power quality is usually related to a disturbance that occurs in voltage, current, and frequency. Power quality is a big concern for suppliers and consumers. The effect is caused by a lack of power quality felt in some countries, where billions of dollars were spent only to improve poor power quality. The main reason is that some industries do not wish to renew their plants. Over the past few years ago, the power quality has been a problem that was discussed throughout the country. The main problem is the sensitivity of electrical equipment related to power quality is lower than before. Some of the problems that affected on power quality are voltage dip (sag), swell (increase in voltage amplitude), interruption (loss of

amplitude), harmonics and frequency variations [1]. Voltage sag is a phenomenon of Root Mean Square (RMS) voltage reduction in a short time during short circuit conditions, overloads, and starting large-capacity motors [1]. Attention to sag voltage is quite large because it can cause damage to some sensitive equipment such as adjustable-speed drives, process-control equipment, and computers. Some parts of the equipment will trip if the RMS voltage is below 90% for a time of more than one or two cycles [2]. Voltage sag can occur during short circuits conditions hundreds of time from several kilometers away on an electric power transmission system. Disruption of short circuits such as 1 phase to ground, phases and 3 phases is a frequent interference, although this interference is temporary and lasts relatively short, this event can cause a momentary voltage drop. Voltage sag (dip) is a decrease in RMS voltage with duration of 0.5 cycles for 1 minute [3].

II. LITERATURE REVIEW

A. Power Quality

The term power quality is commonly used in the recent years in the field of electric power systems. Sag voltage is a part of the power quality problems, which also known as the dip [4]. Power quality could interpret as the ability to meet electrical energy needs without interruption. Power quality is a global issue that is a major concern for suppliers and customers [5]. Power quality problems have a variety of different problems. Each problem has a variety of different causes and different solutions that be used to improve power quality and equipment performance [5]. Some of the problems that affected to power quality are voltage sag, voltage increase, interruption, transient, flicker, harmonics and frequency variations. These problems can have an effect on consumer equipment, damage, and losses due to loss of production [6].

B. Voltage Sag

Definition of voltage sag based on the IEEE 1159-1995 standard is reduction of rms voltage for a short duration to an extent between 0.1 and 0.9 pu [7, 8]. Duration of sag is seen in between 0.5 cycles and 1 min. Sag is often called as voltage dip. In Figure 1, voltage sag occurs and returns to normal after 0.12 seconds [2]. Measurement of voltage sag to x (volts or percent) is given in the percentage or also called sag to, voltage sag to 60% is equal to 60% of nominal voltage or 288 Volt to 480 Volt in the system [9]. Voltage sag is generally understood as the amount where the nominal voltage decreases in percentage. Thus, the voltage that is positioned 40% is equal to Voltage Sag to 60% [10].

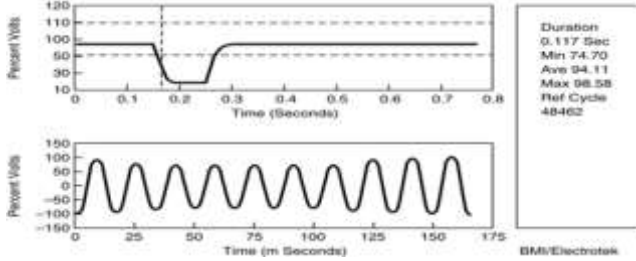

Figure 1: Voltage sag plot [2].

Voltage sag could occur on distribution and transmission lines. Voltage sag that occurs at high voltage will spread to utility systems and will transmitted to a low voltage system via a transformer, as in Figure 2 [10].

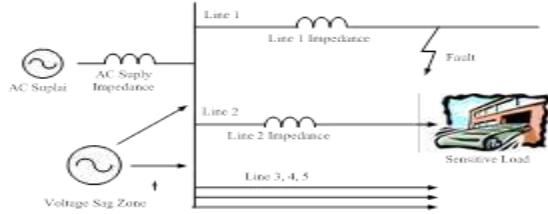

Figure 2: Modeling of voltage sag affected to the systems [10].

Voltage sag can appear in an industry, in general, there are two causes of voltage sag, which is due to a fault in the system and the ignition of a large power induction motor. Obtaining the voltage sag obtain single phase to ground fault occurs, by the following equation [11].

1) Positive Sequence Voltage

Positive sequence voltage has single phase to ground fault obtained by using the following equation [11].

$$V_{+real} = V_{bus} - \left(\frac{I_{L-G}}{3}\right) \times Z_{1JAR} \times \cos \theta \quad (1)$$

$$V_{+imj} = 0 - \left(\frac{I_{L-G}}{3}\right) \times Z_{1JAR} \times \sin \theta \quad (2)$$

2) Negative Sequence Voltage

Negative sequence voltage has single phase to ground fault obtained by using the following equation [11].

$$V_{-real} = -\left(\frac{I_{L-G}}{3}\right) \times Z_{2JAR} \times \cos \theta \quad (3)$$

$$V_{-imj} = -\left(\frac{I_{L-G}}{3}\right) \times Z_{2JAR} \times \sin \theta \quad (4)$$

3) Zero Sequence Voltage

Zero sequence voltage on single phase to ground fault is obtained using the following equation [11].

$$V_{0real} = -\left(\frac{I_{L-G}}{3}\right) \times Z_{0JAR} \times \cos \theta \quad (5)$$

$$V_{0imj} = -\left(\frac{I_{L-G}}{3}\right) \times Z_{0JAR} \times \sin \theta \quad (6)$$

Then the voltage dip when the single line to ground short circuit uses the following equation [11].

$$V_{Sag\ 1\phi} = \sqrt{(\Delta V_{real})^2 + (\Delta V_{imj})^2} \angle \tan^{-1} \left(\frac{\Delta V_{imj}}{\Delta V_{real}}\right) \quad (7)$$

Where

$$\Delta V_{real} = V_{+real} + V_{-real} + V_{0real} \quad (8)$$

$$\Delta V_{imj} = V_{+imj} + V_{-imj} + V_{0imj} \quad (9)$$

III. RESEARCH METHODOLOGY

The research methodology conducted in this study is shown in Figure 3.

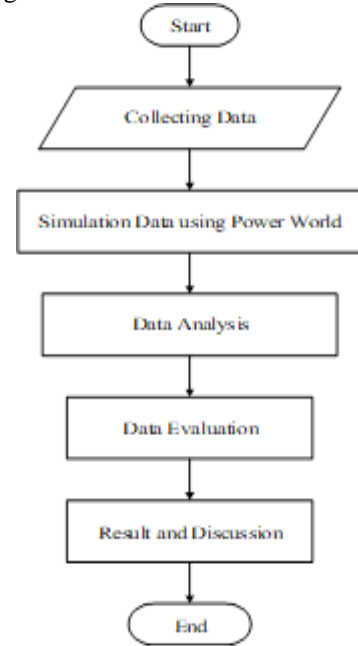

Figure 3: Research flowchart.

IV. RESULTS AND DISCUSSION

PT. PLN (Persero) Electric power transmission sub system Central Sumatera supplied by Hydroelectric Power Plants, Steam Power Plants, Combined Cycle Power Plant, Diesel Power Plants, Gas Power Plants, and Gas Engine Power Plants. System is connected by 150 kV over headline high voltage transmission system, to deliver excessive power in one region to another region that lacks power. There are in addition power generation units that supply power to the region's subsystem to meet the power needs of each region. The Central Sumatera sub system Load Management Unit is one of the units of PT. PLN (Persero) in charge of managing the operation of the electric power system in West Sumatera, Riau and Jambi.

Central Sumatera sub system Single Line as showed in Figure 4. This research begins by calculating the line impedance at the point of interference of 5%, 10%, 25%, and 75% of the 150 kV over head high voltage system. Especially at the Balai Pungut to Duri, Singkarak to Lubuk Alung and Payoselincah-Aur Duri. Then, process simulates the short circuit current on single phase to

ground and three phases by using the Powerworld Simulator 7.0 Students Edition program. After obtaining the results of impedance and short circuit fault current, a calculation performed to de termine the voltage sag when a fault occurs.

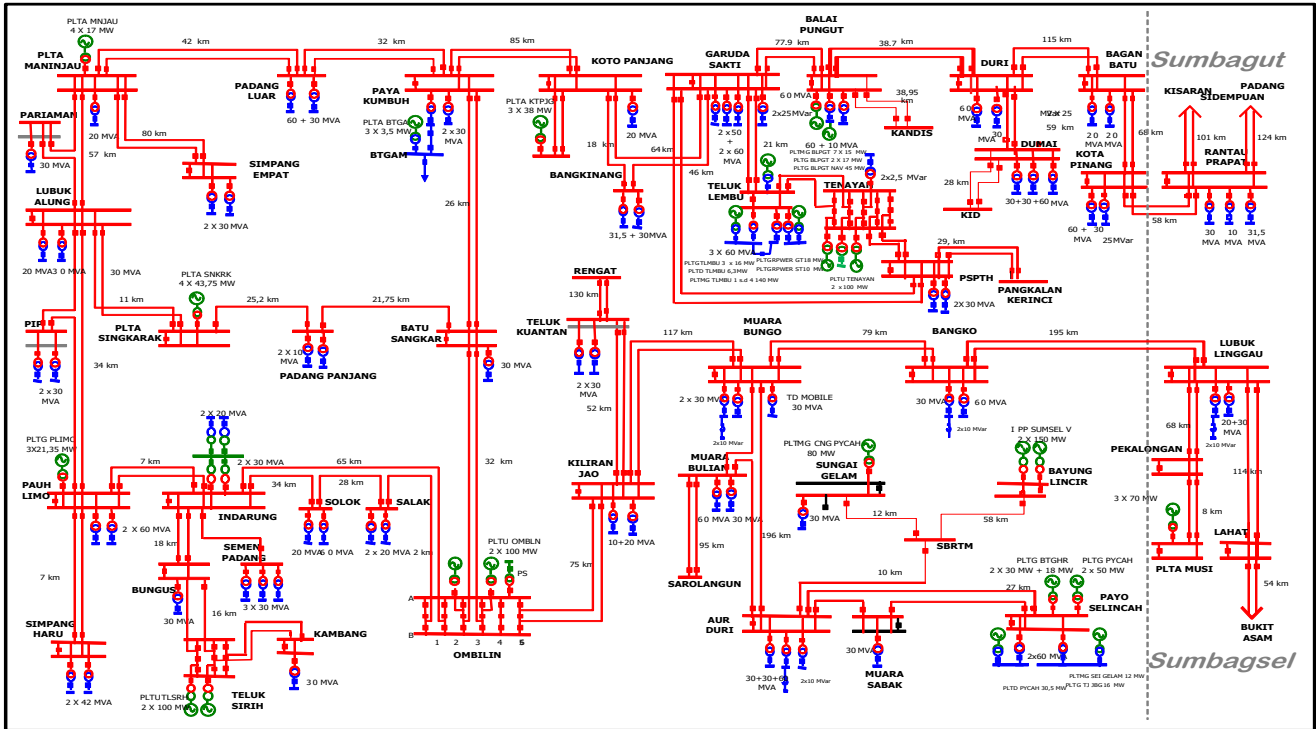

Figure 4: Single line diagram of sub system in Central Sumatera

A. Voltage Sag on Balai Pungut – Duri

Voltage sag is obtained based on the value of short circuit and in this study using Powerworld Simulator 7.0 Students Edition program. Fault location at the line of 5%, 10%, 25%, and 75% then the results are as showed in Table 1. The comparison graph of the Voltage Sag of the Balai Pungut-Duri when single phase to ground and three phases fault as showed in Figure 5.

Table 1: Voltage sag on Balai Pungut-Duri lines caused by single phase to ground and three phase faults

Fault Location	Single Phase to Ground	Three Phase
5%	49,059.79 $\angle 0,73^\circ$	3,474.62 $\angle -88,05^\circ$
10%	48,153.65 $\angle 1,42^\circ$	6,808.70 $\angle -88,20^\circ$
25%	45,737.66 $\angle 3,50^\circ$	16,152.17 $\angle -88,55^\circ$
75%	39,348.00 $\angle 10,95^\circ$	44,087.55 $\angle -88,77^\circ$

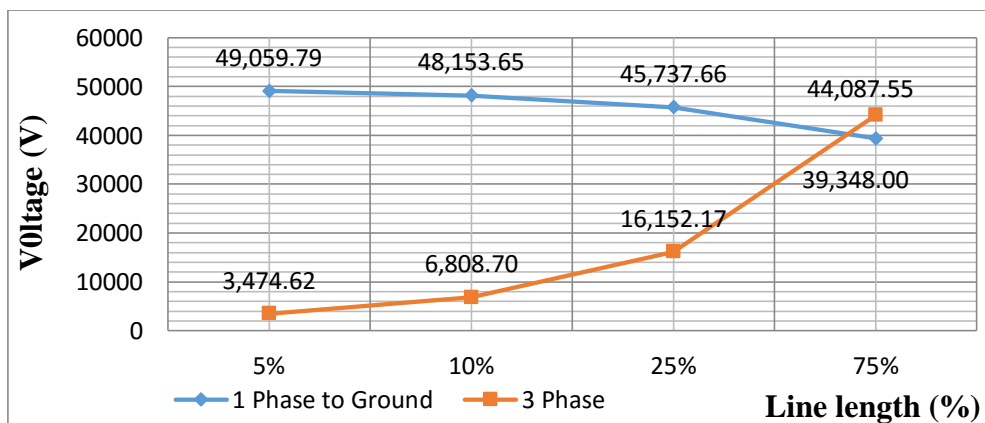

Figure 5: Comparison chart of voltage sag on Balai Pungut – Duri lines.

B. Voltage Sag on Singkarak-Lubuk Alung

Voltage sag when there is a short circuit single phase to ground and three phase short circuit fault at 5%, 10%, 25%, and 75% at Singkarak-Lubuk Alung. Then, the comparison voltage sag at Singkarak and Lubuk Alung as shown in Table 2. Graph of the voltage of the Singkarak-Lubuk Alung voltage when single phase to ground and three phases fault as shown in Figure 6.

Table 2: Singkarak-Lubuk Alung voltage sag

Fault Location	Single Phase to Ground	Three Phase
5%	49.747,50 $\angle 0,29^\circ$	668,08 $\angle -81,18^\circ$
10%	49.499,24 $\angle 0,58^\circ$	1.331,44 $\angle -81,24^\circ$
25%	48.773,65 $\angle 1,47^\circ$	3.307,15 $\angle -81,40^\circ$
75%	46.389,84 $\angle 4,77^\circ$	10.153,89 $\angle -88,60^\circ$

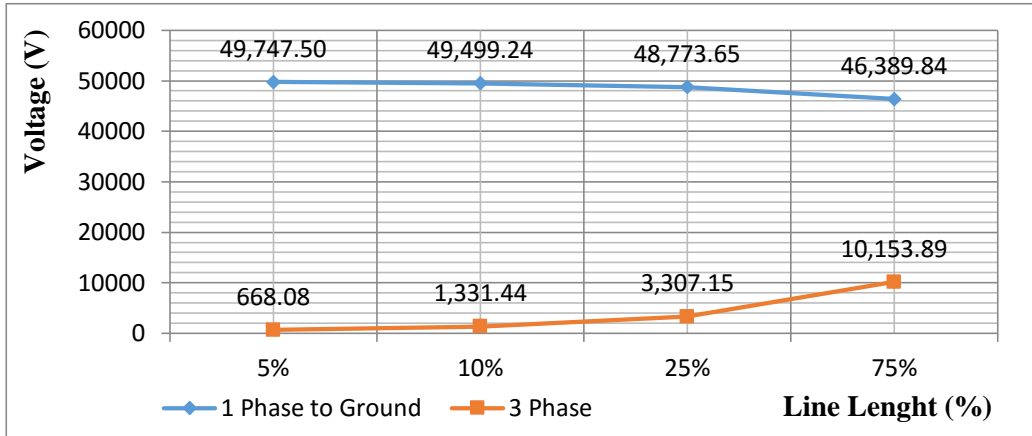

Figure 6: Comparison graph of voltage sag on Singkarak-Lubuk Alung lines

C. Voltage Sag on Payoselincah-Aur Duri

There is a short circuit single phase to ground and three phase short circuit fault at the 5%, 10%, 25%, and 75% of the line. Then, comparison of voltage sag at Payoselincah and Aur Duri as shown in Table 3. Graph of the voltage sag of Payoselincah-Aur Duri when single phase to ground and three phases fault as shown in figure 7.

Table 3: Voltage Sag on Payo Silincah-Aur Duri lines

Fault Location	1 Phase to Ground	3 Phasa
5%	48.573,24 $\angle -0,58^\circ$	1.911,37 $\angle -45,89^\circ$
10%	47.180,62 $\angle -1,19^\circ$	3.798,33 $\angle -45,89^\circ$
25%	43.165,76 $\angle -3,21^\circ$	9.356,98 $\angle -45,89^\circ$
75%	30.607,52 $\angle -13,70^\circ$	28.002,26 $\angle -45,89^\circ$

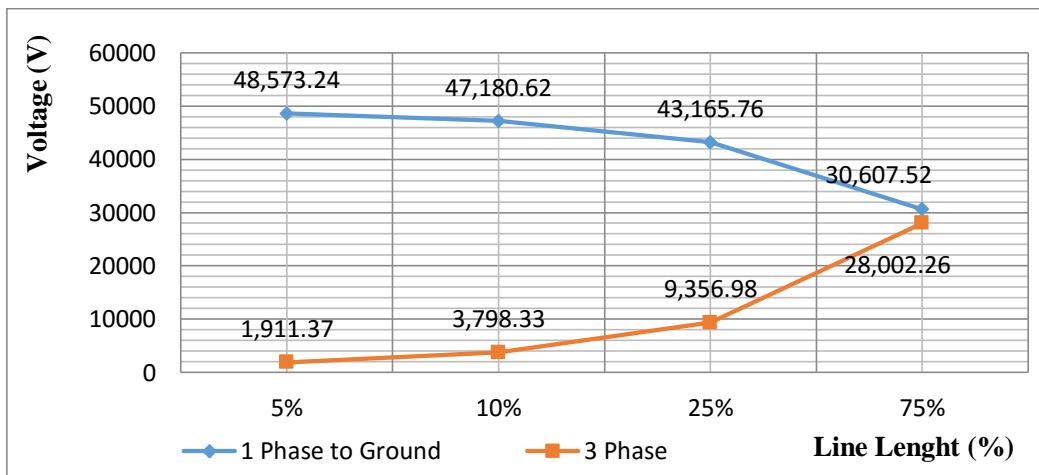

Figure 7: Comparison graph of the voltage sag on Payoselincah-Aur Duri lines

V. CONCLUSION

The Voltage Sag when there is a single line to ground short circuit on Balai Pungut-Duri at 5%, 10%, 25% and 75% of the line are 49,059.79 V, 48,153.65 V, 45,737, 66 V, and 39,348.00 V. The voltage sag when three phase short circuit occurs at 5%, 10%, 25% and 75% of the line are 3,474.62 V, 6,808.70 V, 16,152.17 V, and 44,087.55 V respectively. a single line to ground short circuit on the Singkarak - Lubuk Alung line at 5%, 10%, 25% and 75% of the line are 49,747.50 V, 49,499.24 V, 48,773, 65 V, and 46,389.84 V. the three phase short circuit fault occur at at 5%, 10%, 25% and 75% of the line are 668.08 V, 1,331.44 V, 3,307.15 V, and 10,153.89 V. Then, there is a single line to ground short circuit on the Payoselincah - Aur Duri at 5%, 10%, 25% and 75% of the line are 48,573.24 V, 47,180.62 V, 43,165.76 V, and 30,607.52 V respectively. While the Voltage Sag when the three phase short circuit fault at 5%, 10%, 25% and 75% of the line are 1,911.37 V, 3,798.33 V, 9,356.98 V, and 28,002.26 V respectively. The biggest percentage voltage sag is then that there is a single line to the ground short circuit fault occurs on Balai Pungut-Duri, Singkarak - Lubuk Alung and Payoselincah - Aur Duri line is at the 75%. The smallest voltage sag is 5% fault location. The biggest percentage of voltage sag when there are a three phase short circuits in the Balai Pungut-Duri, Singkarak-Lubuk Alung and Payoselincah-Aur Duri line is at the 5% fault location and the smallest Voltage Sag is at the 75%.

REFERENCES

- [1] M. H. J. "Bollen, Understanding Power Quality Problems, Voltage Sag and Interruptions", John Wiley, New York, 2000.
- [2] B. W. Kennedy, "Power Quality Primer. New York", McGraw-Hill, 2000.
- [3] R. S. Vedam, M. S. Sarma, "Power Quality: VAR Compensation in Power Systems", CRC Press, London, 2009.
- [4] M. N. Sinha, B.R.Parekh, "Simulation of Voltage Sag Magnitude Estimation in a Power System Network," Res. Rev. - Int. Journals Int. J. Adv. Res. Electr. Electron. Instrum. Eng., vol. 3, no. 2, pp. 7410–7415, 2014.
- [5] R. C. Dugan, S. Santoso, M. F. McGranaghan, H. W. Beaty, "Electrical Power Systems Quality", 2nd ed. McGraw-Hill Education, 2002.
- [6] A. Chowdhury and D. Koval, "Power Distribution System Reliability: Practical Methods and Applications", Wiley, New Jersey, 2011.
- [7] IEEE and Institute of Electrical and Electronic Engineers, "IEEE Std 1159 - IEEE Recommended Practice for Monitoring Electric Power Quality", 2009.
- [8] L. Zhang and M. H. J. Bollen, "A method for characterisation of three-phase unbalanced dips (sags) from recorded voltage waveshapes", 21st International Telecommunications Energy Conference. INTELEC '99 (Cat. No.99CH37007), p. 188, 1999.
- [9] R. K. Sinha, R. Kumar, M. Venmathi, L. Ramesh, "Analysis of Voltage Sag with Different DG for Various Faulty Conditions," Int. J. Comput. Commun. Inf. Syst., vol. 2, no. 1, pp. 189–193, 2010.
- [10] I. K. P. Ross, "Voltage Sags an Explanation Causes, Effects, and Correction", 2006.
- [11] C. L. Wadhwa, "Electrical Power System", New Academic Science, 2012.